





The importance of Gate Cooling

When designing a mould for a direct gated part that uses a Hot Runner System it is critical to consider effective cooling at the gate and in the Hot Runner System plates.

Inadequate gate cooling can result in poor gate vestige and/or extended cycle times. Part quality issues such as splay or bloom can also result from a poorly designed tool.

Insufficient cooling in the back plate or manifold housing plate can result in excessive heat transfer to the rest of the mould or machine platen, plate distortion or insufficient sealing forces within the Hot Runner System.

KEY	
	Water In Cooling Circuit
	Water Out Cooling Circuit
	Back Plate
	Manifold Plate
	Manifold

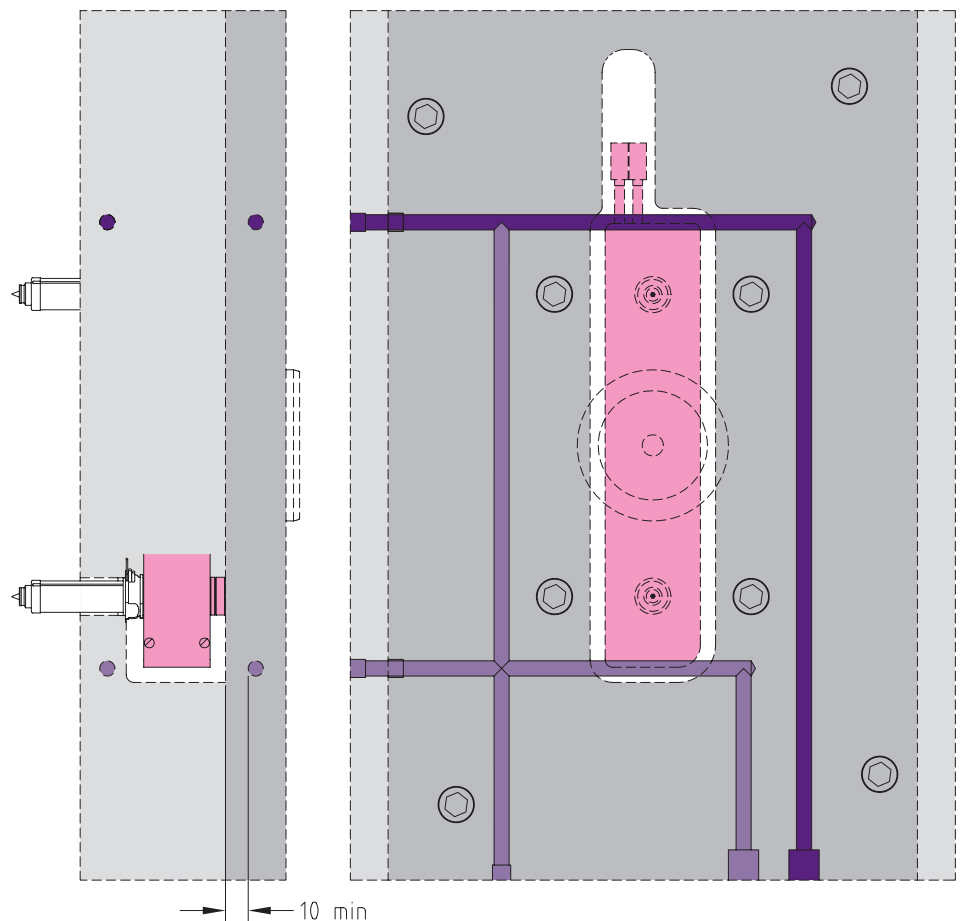





During the initial tool design process it is important to consider the following influential factors when considering gate cooling.

- Gate Insert design and material
- Distance of circuit from gate
- Thermal conductivity of insert
- No part line between gate and circuit
- Controllability



Gate Cooling

Gate Cooling needs to be on a separate circuit to the mould plate.

KEY	
	Water In Cooling Circuit
	Water Out Cooling Circuit
	Manifold Plate
	Cavity Plate

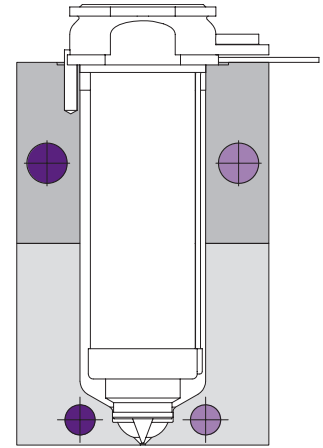
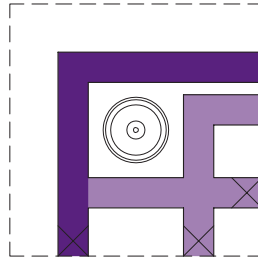

Dimples

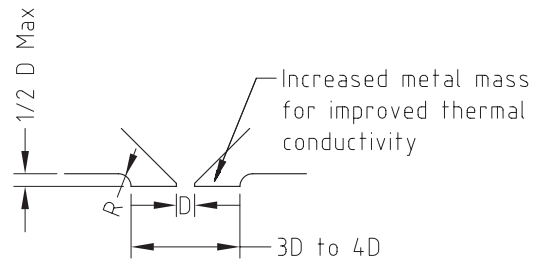
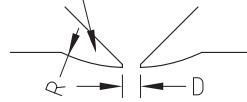

Design dimples for maximum material thickness around gate

Thin areas reduce metal mass and reduce thermal conductivity and gate control



Valve Gate Cooling Circuits

Manifold plate circuit
Back plate circuit
Valve Gate cylinders require cooling on two sides of cylinders

KEY	
	Cooling Circuit
	Airway

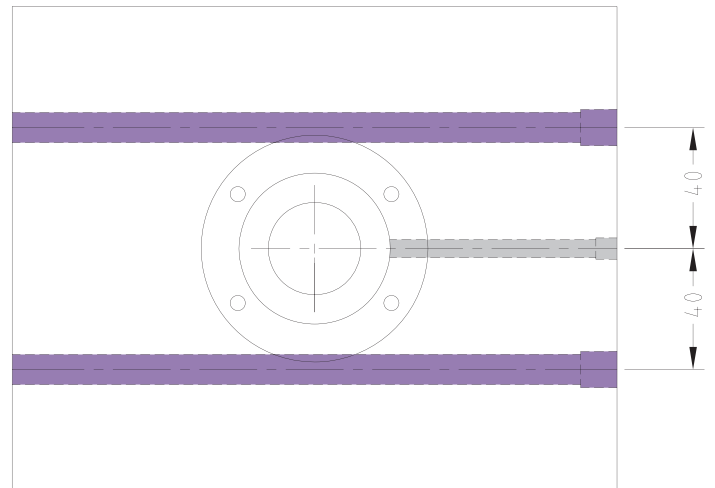

Successful Tooling Projects

Proper tool design will result in efficient cycle times, good part quality and efficient transition of new tooling into full production.

Your Mastip Technology engineering team is available for consultation during the tool design process to ensure that your new tooling project becomes a success.

Mastip Head Office New Zealand

550 Rosebank Road
Avondale, Auckland, New Zealand
PO Box 90651, Victoria Street West,
Auckland 1142, New Zealand
Phone: +64 9 970 2100
Fax: +64 9 970 2070
Email: mastip@mastip.com

Mastip Regional Office Europe

Phone: +33 4 724 72 800
Fax: +33 4 724 72 801
Email: europe@mastip.com

Mastip Regional Office China

Phone: +86 21 644 77838
Fax: +86 21 644 77828
Email: china@mastip.com

Mastip Regional Office North America

Phone: +1 262 644 9400
Fax: +1 262 644 9402
Email: northamerica@mastip.com