

# SC8

## Sequence Injection Controller

### User Guide

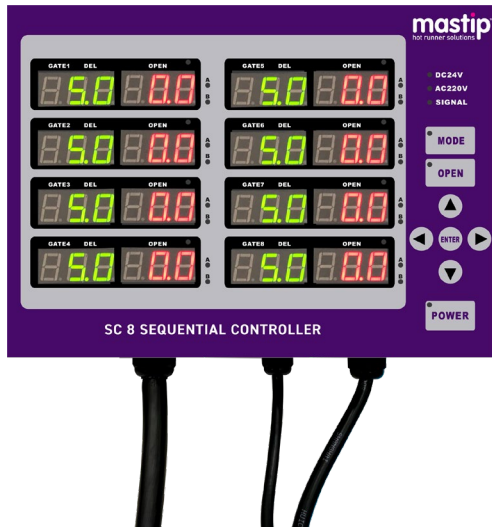

## 1. Warranty

We warrant that this product will be free from defects in materials and workmanship for a period of 18 months from the date of shipment. If any such product proves defective during this warranty period, at our option, either will repair the defective product without charge for parts and labour, or will provide a replacement in exchange for the defective product.

This warranty shall not apply to any defect, failure or damage caused by improper use or improper or inadequate maintenance and care. We shall not be obligated to furnish service under this warranty; a) to repair damage resulting from attempts by personnel other than our representatives to repair or service the product; b) to repair damage resulting from improper use or connection to incompatible equipment; or c) to service a product that has been modified or integrated with other products when the effect of such modification or integration increases the time or difficulty of servicing the product.

This warranty excludes replacement of fuses and damage to the product from the use of improper fuses. The maximum allowable fuse rating is 3 amps (10 amps for DC24V/240W output) . Lower ratings may be used for improved protection.

## 2. Safety

This product has been designed to be safe and simple to operate. As with any electronic equipment, you must observe standard safety procedures to protect both yourself and the equipment.

### To Prevent Injuries:

- do not apply voltage to a terminal that exceeds the range specified for that terminal.
- do not operate this product when wet.
- do not operate this product in an explosive atmosphere.

### To Prevent Product Damage:

- Do not operate this product from a power source that applies more than the voltage specified.
- Do not operate this product from an injection signal input that mismatches the setting.
- Do not operate this product from a solenoid valve where its power source mismatches the gate output type setting.

## 3. Specifications

- Power requirements: AC85~265V, 50/60Hz

- Injection signal input (Selected by JP1 on PCB): DC24V/AC220V
- Gate output
  - 1) DC24V (50W or 240W for total 8 gates)
  - 2) AC220V (less than 100mA per gate, the voltage is the controller's power source) , total 8 gates
- Operating mode: Mode A, Mode B or Mode AB
- Time range: 0~999s, 0.0~99.9s, or 0.00~9.99s
- Operating condition: 0°C~55°C (32°F~131°F), 10~80% (non-condensing)
- Storage temperature: -20°C~70°C (-4°F~158°F)

#### 4. Faceplate

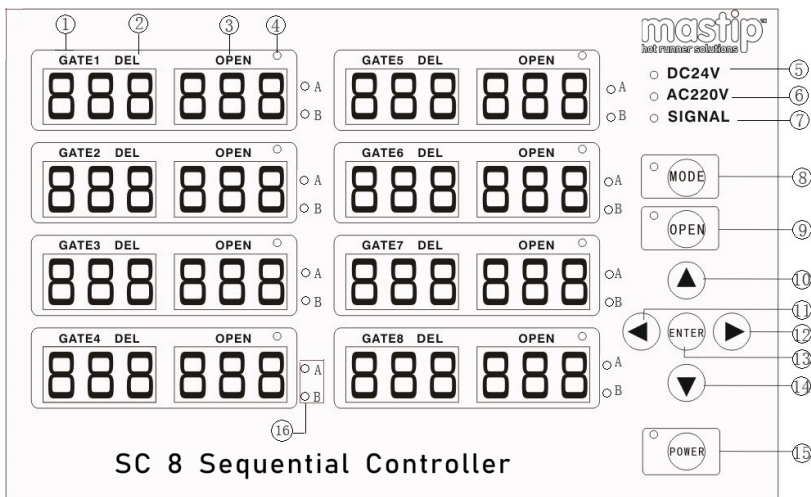

- 1) **Gate number:** Gate1~Gate8.
- 2) **Delay time display:** Shows delay time of corresponding gate; green.
- 3) **Open time display:** Shows open time of corresponding gate; red.
- 4) **Gate indicator:** Corresponding gate is selected.
- 5) **DC24V output light:** DC24V output is selected.
- 6) **AC220V output light:** AC220V output is selected.
- 7) **Injection signal input indicator:** Indicates the state of injection input signal.
- 8) **MODE key:** Used to select operating mode & time range  
**MODE indicator:** Mode key is selected
- 9) **OPEN key:** Used to open all gates or the gate selected manually.

**OPEN indicator:** Open key is selected.

**10) & 14) Up & Down arrow:** Used to select gate for setting operating mode, time range and open gates manually; used to change the number for setting delay & open time.

**11) & 12) Left & Right arrow:** Used to select operating mode or time range if mode key is selected; used to select the time display unit for setting delay & open time.

**13) Enter key:** Used to finalize setting or exit the gate selected.

**15) Power key:** Used to turn on/off the controller.

**Power indicator:** Blinks after connected power and lights after the controller is turned on.

**16) Operating mode indicator:** Indicates the operating mode of corresponding gate.

## 5. Injection Signal Input Setting

**Caution:** Please set the jumpers JP1 (on PCB) correctly. Otherwise, it may damage the controller.

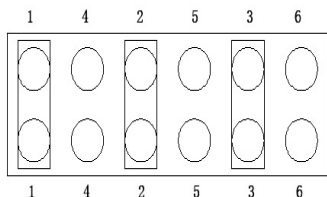

JP1 setting for Switch Input

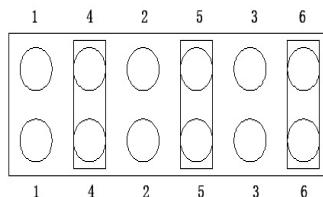

JP1 setting for DC24V/AC220V Input

## 6. Gate Output Setting

**Caution:** Please set the band switch (covered by a panel) on the side of the product correctly. Otherwise, it may cause the controller or solenoid valve damaged.

**Comment:** The band switch on the product is one of the following. Please specify which is required at time of order)



## 7. Operating Mode

◆ **Mode A:**

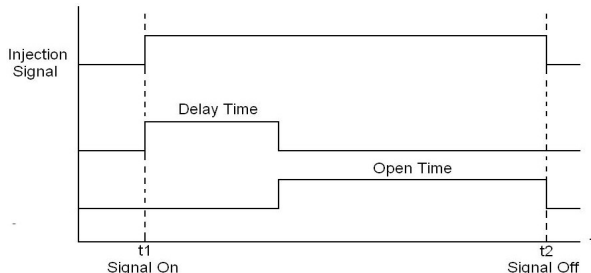

- 1) When the controller receives the injection signal ( $t_1$ ), delay time begins.
- 2) The controller counts down the delay time and displays it on DEL display unit.
- 3) At the end of delay time, the controller opens the gate output, counts the open time and shows it on OPEN display unit.
- 4) The controller keeps the gate output open until the injection signal is off ( $t_2$ ).
- 5) When the injection signal is off, the controller resets the delay time and shows it on DEL display unit. And the counted open time is showed on OPEN display unit until the next injection signal comes on.
- 6) If the injection signal is off before the delay time passed, the controller will reset the delay time and wait for the next injection signal.

◆ **Mode B:**

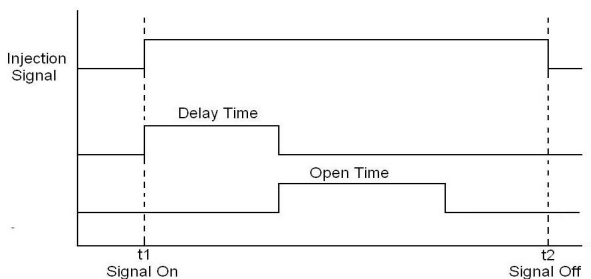

- 1) When the controller receives the injection signal ( $t_1$ ), delay time begins
- 2) The controller counts down the delay time and displays it on DEL display unit.
- 3) At the end of delay time, the controller opens the gate output, counts the open time and shows it on OPEN display unit.
- 4) At the end of open time, the controller closes the gate output.
- 5) When the injection signal is off ( $t_2$ ), the controller resets the delay time & open time, and shows them on DEL & OPEN display units.
- 6) If the injection signal is off before the delay time passed, the controller will reset the delay

time and wait for the next injection signal.

- 7) If the injection signal is off before the open time passed, the controller will close the gate output, and reset the delay time & open time.

◆ **Mode AB:**

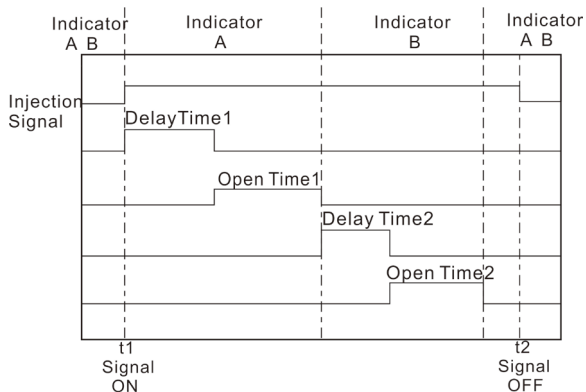

- 1) When the controller receives the injection signal (t1), the indicator A is lit up and delay time1 begins.
- 2) The controller counts down the delay time1 and displays it on DEL display unit.
- 3) At the end of delay time1, the controller opens the gate output, counts the open time1 and shows it on OPEN display unit.
- 4) At the end of open time1, the controller closes the gate output.
- 5) Then the indicator B is lit up and delay time2 begins.
- 6) At the end of delay time2, the controller opens the gate output, counts the open time2 and shows it on OPEN display unit.
- 7) At the end of open time2, the controller closes the gate output.
- 8) When the injection signal is off (t2), the controller resets the delay time & open time, and shows delay time 1 & open time 1 on DEL & OPEN display units.
- 9) If the injection signal is off before the delay time1 passed, the controller will reset the delay time and wait for the next injection signal.
- 10) If the injection signal is off before the open time1 passed, the controller will close the gate output, and reset the delay time and open time.
- 11) If the injection signal is off before the delay time2 passed, the controller will reset the delay time and open time, then wait for the next injection signal.
- 12) If the injection signal is off before the open time2 passed, the controller will close the gate output, and reset the delay time and open time.

## 8. Operation

### ◆ Power on

- 1) Before powering on the controller, please confirm the connections are correct, the input setting matches the injection signal, the output type matches the solenoid valve, and the power source matches the voltage specified.
- 2) Switch on the power source, the power indicator blinks.
- 3) Press the POWER key for 3s to turn on the controller, the power indicator lights.
- 4) Check the display units and the indicators state to confirm the controller is ok and the setting is required is correct.

### ◆ Power off

Press the POWER key for 3s to turn off the controller, the power indicator blinks.

### ◆ Select operating mode or shut off the gate selected

- 1) Press MODE key for 4s, MODE indicator and the gate indicator of gate1 blinks.
- 2) Press < or > to select the operating mode of gate1.  
Both A&B indicators blinking indicates AB mode, and both A&B going off means to shut off this gate.
- 3) Press  $\wedge$  or  $\vee$  to select the gate and repeat step 2).  
At the same time, the operating mode setting is saved.
- 4) Press ENTER key to save the setting and exit the procedure.

### ◆ Select time range

- 1) Press  $\wedge$  or  $\vee$  to select the gate, corresponding gate indicator blinks.
- 2) Press MODE key for 4s, MODE indicator blinks and the selected gate DEL display unit shows "Unl", OPEN display unit shows "9.99" or "99.9 or "999".
- 3) Press < or > to select the time range of this gate.
- 4) Press  $\wedge$  or  $\vee$  to select the gate and repeat step 3).  
At the same time, the time range setting is saved.
- 5) Press ENTER key to save the setting and exit the procedure.

### ◆ Set delay time and open time

- 1) Press < or > to set delay or open time, the corresponding display unit blinks.

**Note: In the AB Mode, when the indicator A blinks, you can set the first group of delay & open time, and when the indicator B blinks, you can set the second group of delay & open time.**

- 2) Press  $\wedge$  or  $\vee$  to change the number, the blinking digit can be modified.  
Press < or > to select the blinking digit.
- 3) Press < or > to select the delay or open time and repeat step 2).  
At the same time, the time setting is saved.
- 4) Press ENTER key to save the setting and exit the procedure.

❖ If there's no operation in 4s during the setting procedure, the controller will exit the procedure without saving automatically.

◆ **Open all gates output manually**

Press OPEN key and hold on, the OPEN indicator lights and the controller open all gates output (gate indicator lights) until the OPEN key is released.

◆ **Open the selected gate output manually**

- 1) Press  $\Lambda$  or Vto select the gate, the corresponding gate light blinks.
- 2) Press OPEN key and hold on, the OPEN indicator lights and the controller open the selected gate output (gate indicator lights) until the OPEN key is released.

### 9. Default Setting

No.	Name	Default Setting
1	Gates in shut off state	No
2	Injection signal input	DC24V or Customized
3	Gate output type	DC24V or Customized
4	Operating mode	Mode A
5	Delay time	5.0 s
6	Open time	6.0s
7	Time range	0.0~99.9s

### 10. Wiring

